

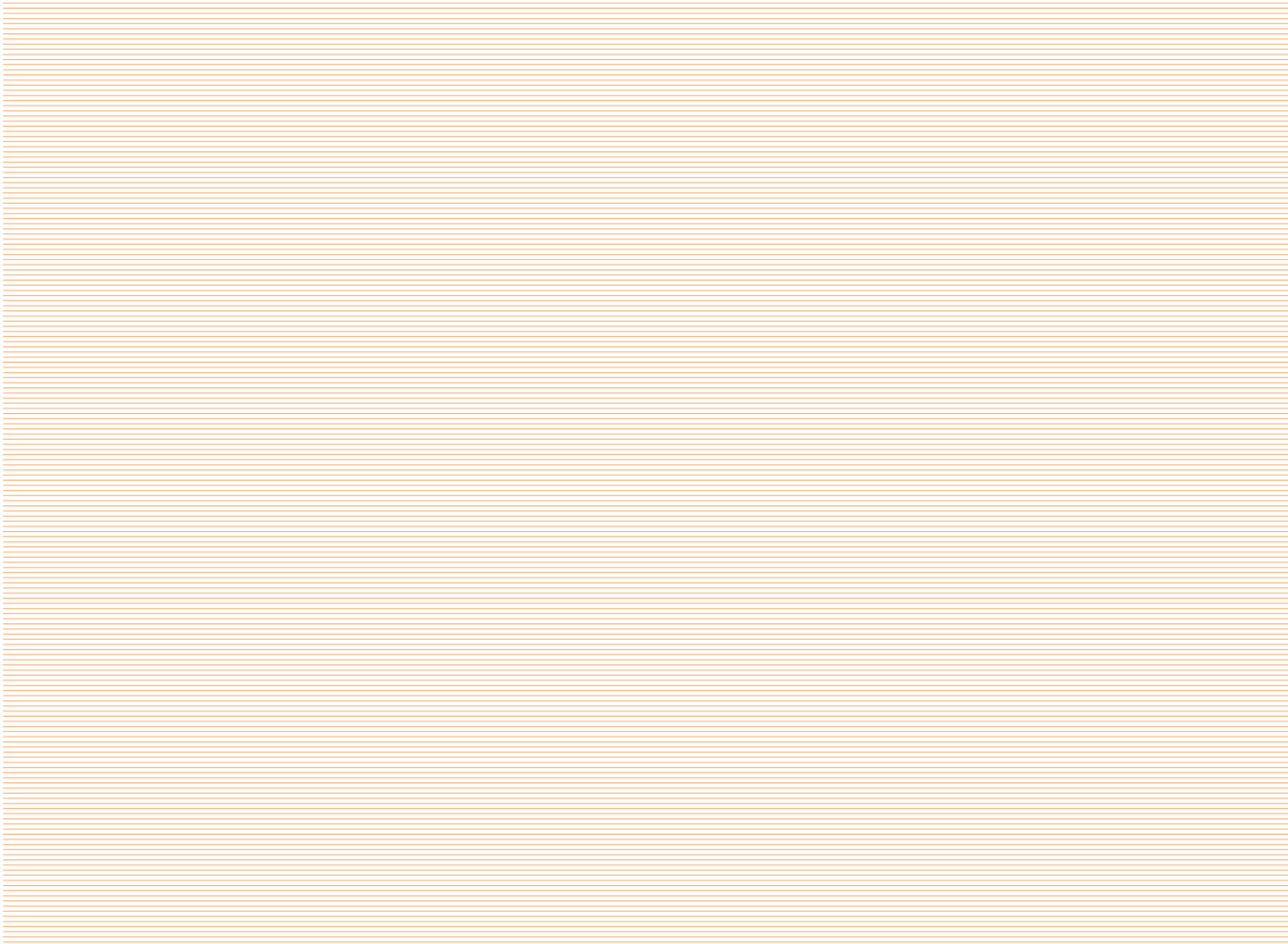

3

Dressing Forceps

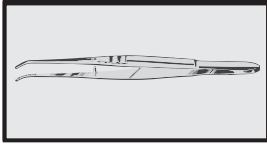



Dressing Forceps



cm	in.	Standard	Standard	Standard	Standard	USA. Mod.	USA. Mod.
10.5	4¼	DC27-001-10	DC27-003-10	DC27-005-10	DC27-007-10		
14.5	5½	DC27-001-14	DC27-003-14	DC27-005-14	DC27-007-14	DC27-009-14	DC27-011-14
16	6½	DC27-001-16	DC27-003-16	DC27-005-16	DC27-007-16		
18	7	DC27-001-18	DC27-003-18	DC27-005-18	DC27-007-18	DC27-009-18	DC27-011-18

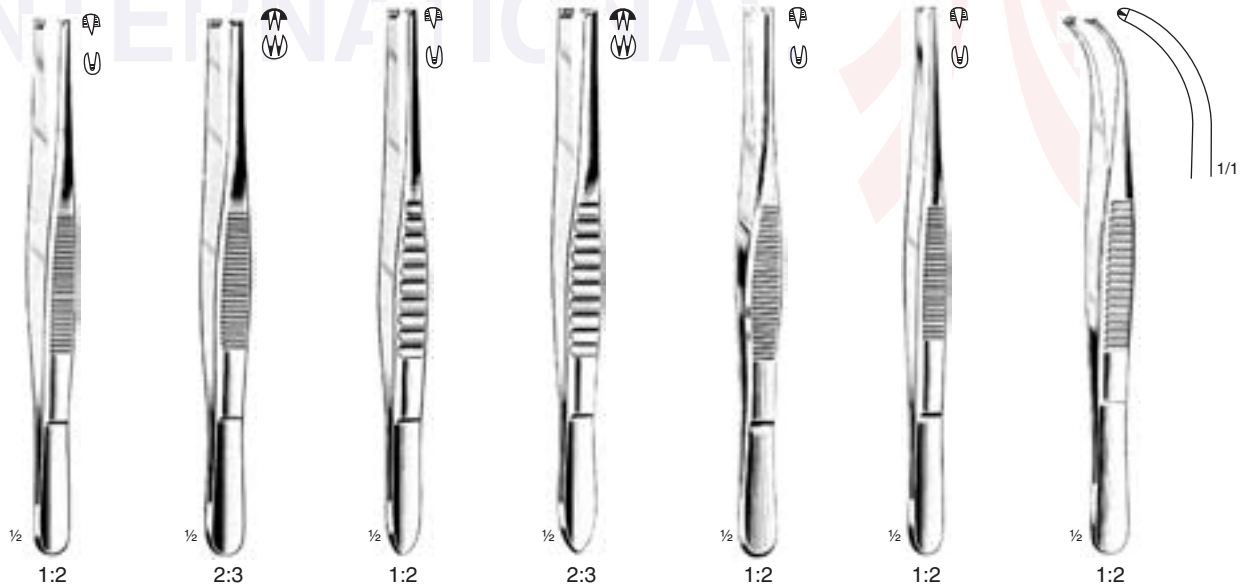

cm	in.							
11	4½	DC27-013-11	DC27-015-11					
14	6	DC27-013-14	DC27-015-14	DC27-017-14	DC27-019-14	DC27-021-14	DC27-023-14	DC27-025-14
16	7	DC27-013-16	DC27-015-16					
18	8	DC27-013-18	DC27-015-18	DC27-017-18	DC27-019-18			

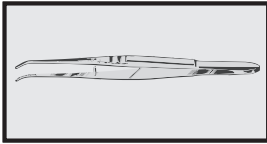

Dressing Forceps

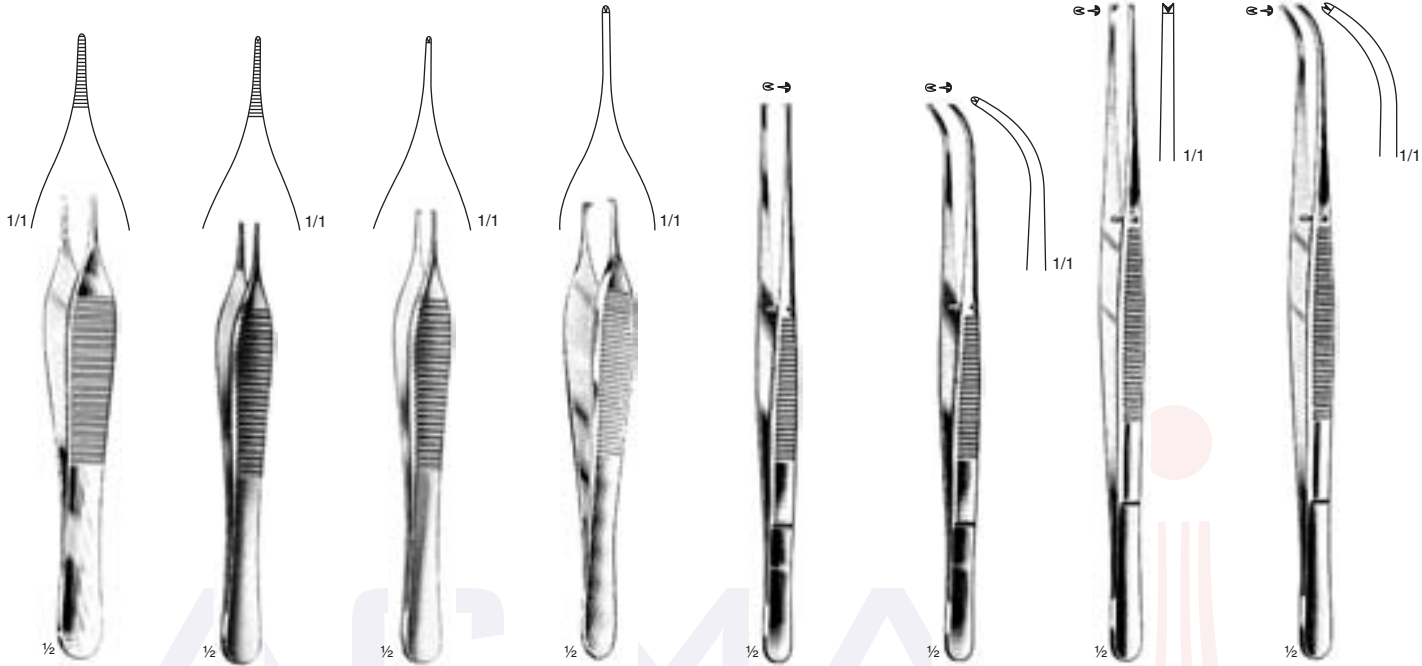

Adson 12 cm / 4¾" DC27-026-12	Micro-Adson 12 cm / 4¾" DC27-027-12	Micro-Adson 12 cm / 4¾" DC27-029-12 1:2	Adson 12 cm / 4¾" DC27-031-12 15 cm / 6" DC27-031-15 1:2	Semken 12.5 cm / 5" DC27-033-12 15 cm / 6" DC27-033-15 1:2	Semken 12.5 cm / 5" DC27-035-12 15 cm / 6" DC27-035-15 1:2	Taylor 17.5 cm / 7" DC27-037-17 1:2	Taylor 17.5 cm / 7" DC27-039-17 1:2
--	--	---	--	--	--	---	---

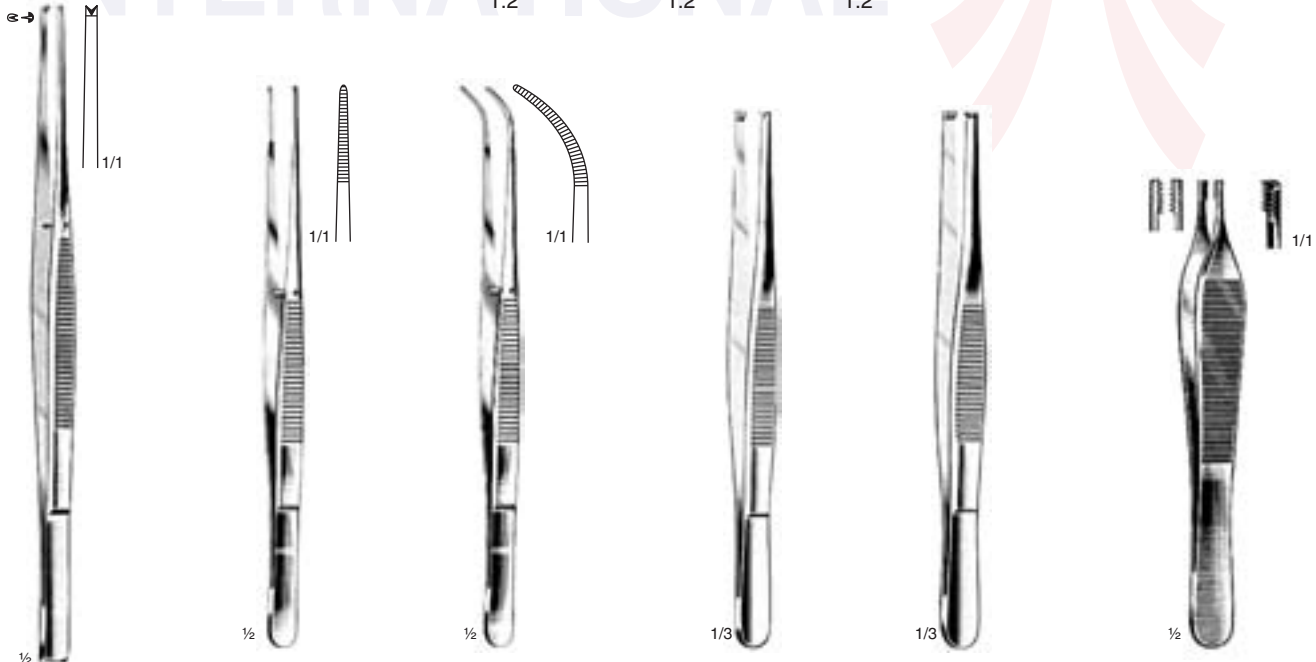

Taylor 17.5 cm / 7" DC27-041-17 1:2	Semken 12.5 cm / 5" DC27-043-12 15.5 cm / 6" DC27-043-15	Semken 12.5 cm / 5" DC27-045-12 15.5 cm / 6" DC27-045-15	Potts-smith 18 cm / 7" DC27-047-18 21 cm / 8¼" DC27-047-21	Potts-smith 18 cm / 7" DC27-049-18 21 cm / 8¼" DC27-049-21	Adson-Brown 12 cm / 4¾" DC27-051-12
---	---	---	---	---	--

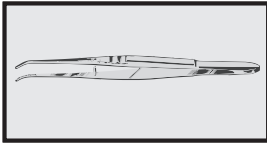

Splinter Forceps

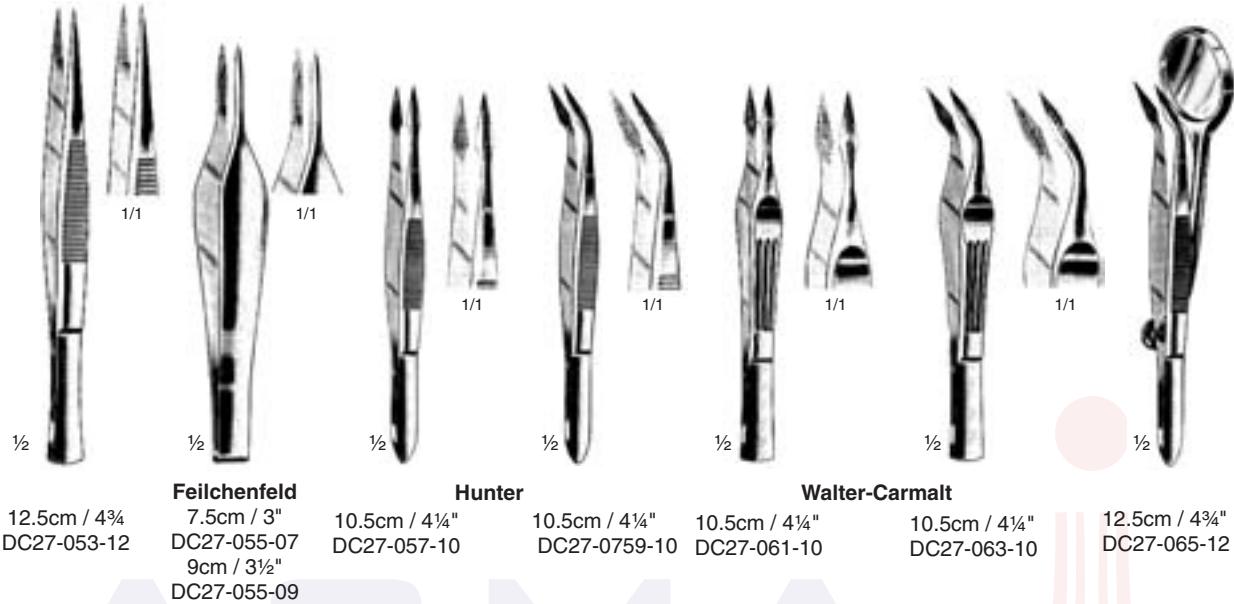

	Feilchenfeld		Hunter		Walter-Carmalt	
12.5cm / 4¾"	7.5cm / 3"	10.5cm / 4¼"	10.5cm / 4¼"	10.5cm / 4¼"	10.5cm / 4¼"	12.5cm / 4¾"
DC27-053-12	DC27-055-07 9cm / 3½"	DC27-057-10	DC27-0759-10	DC27-061-10	DC27-063-10	DC27-065-12
	DC27-055-09					

ACMA
INTERNATIONAL

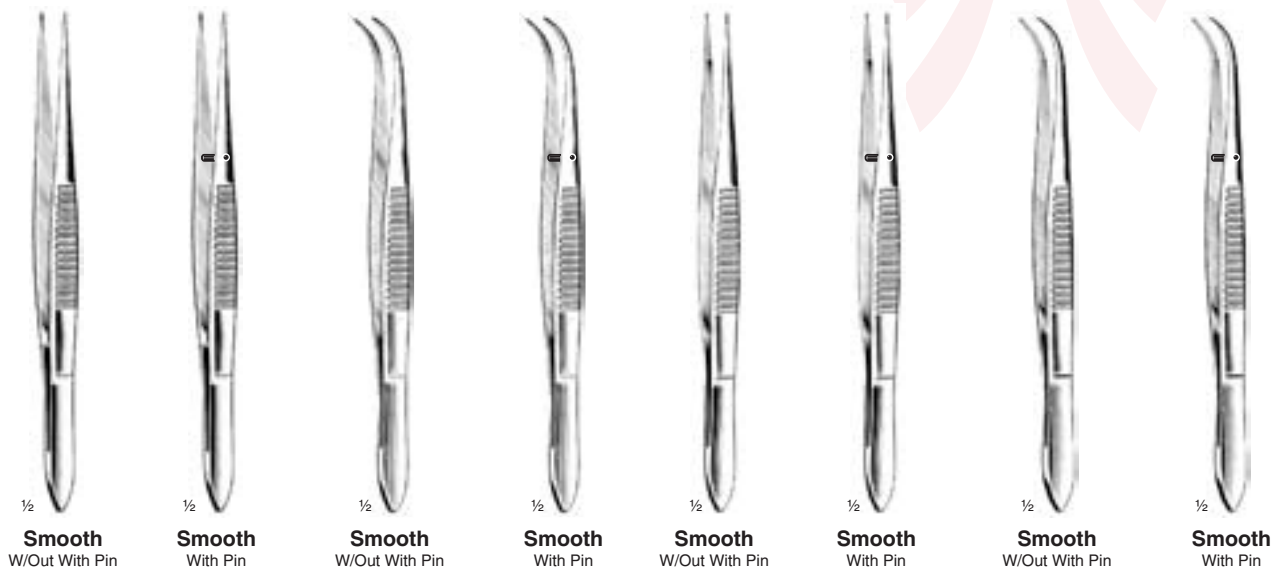

cm	in								
8	3¼	DC27-067-08	DC27-069-08	DC27-071-08	DC27-073-08	DC27-075-08	DC27-077-08	DC27-079-08	DC27-081-08
9	3½	DC27-067-09	DC27-069-09	DC27-071-09	DC27-073-09	DC27-075-09	DC27-077-09	DC27-079-09	DC27-081-09
10.5	4¼	DC27-067-10	DC27-069-10	DC27-071-10	DC27-073-10	DC27-075-11	DC27-077-10	DC27-079-10	DC27-081-10
11.5	4½	DC27-067-11	DC27-069-11	DC27-071-11	DC27-073-11	DC27-075-12	DC27-077-11	DC27-079-11	DC27-081-11
12.5	5	DC27-067-12	DC27-069-12	DC27-071-12	DC27-073-12		DC27-077-12	DC27-079-12	DC27-081-12

Dental Forceps

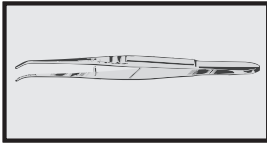

London Collage
15 cm / 6"



1
DC27-083-01



2
DC27-083-02



3
DC27-083-03



4
DC27-085-04



5
DC27-085-05



6
DC27-085-06



7
DC27-085-07



London Collage
15 cm / 6"

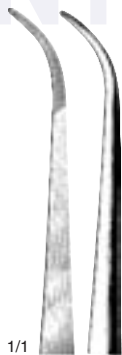

1
DC27-087-01



2
DC27-087-02



3
DC27-087-03



4
DC27-087-04



5
DC27-089-05



6
DC27-089-06



7
DC27-089-07

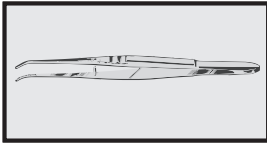

Dental Forceps



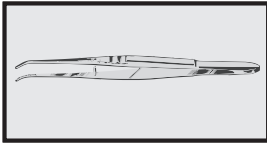

Dental Forceps



Landgraf
15 cm / 6"



1/1
1
DC27-095-01



1/1
2
DC27-095-02



1/1
3
DC27-095-03



1/1
4
DC27-095-04



2/3
Perry
12.5 cm / 5"
DC27-097-12



2/3
Perry
12.5 cm / 5"
DC27-099-12



2/3
Zeibe
12.5 cm / 5"
DC27-101-12



Mod Martin
Suture & Membrane Forceps

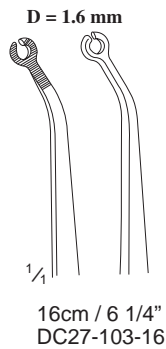

D = 1.6 mm
1/4
16cm / 6 1/4"
DC27-103-16



1/2
Mod Martin
Suture & Membrane Forceps

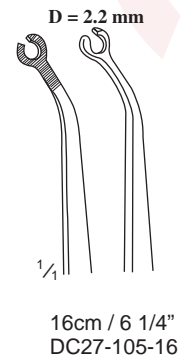

D = 2.2 mm
1/4
16cm / 6 1/4"
DC27-105-16

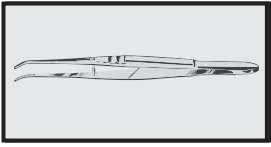

Bracket Holders, Temporary Teeth Forceps



$\frac{2}{3}$
13.5cm/5¼"
DC27-109-01

$\frac{2}{3}$
13.5cm/5¼"
DC27-111-01

$\frac{2}{3}$
14cm/5½"
DC27-113-01



Brom-Allen
16.5 cm/6 ½"
DC27-115-16



$\frac{2}{3}$
Albrecht
16 cm/6 ¼"
DC27-117-16



$\frac{2}{3}$
Albrecht
16 cm/6 ¼"
DC27-119-16



1/1
Miller
15 cm / 6"
DC27-121-16
Practicing Paper
Forcep

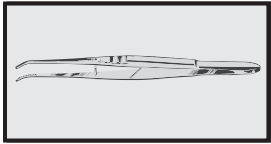

Laboratory Instruments

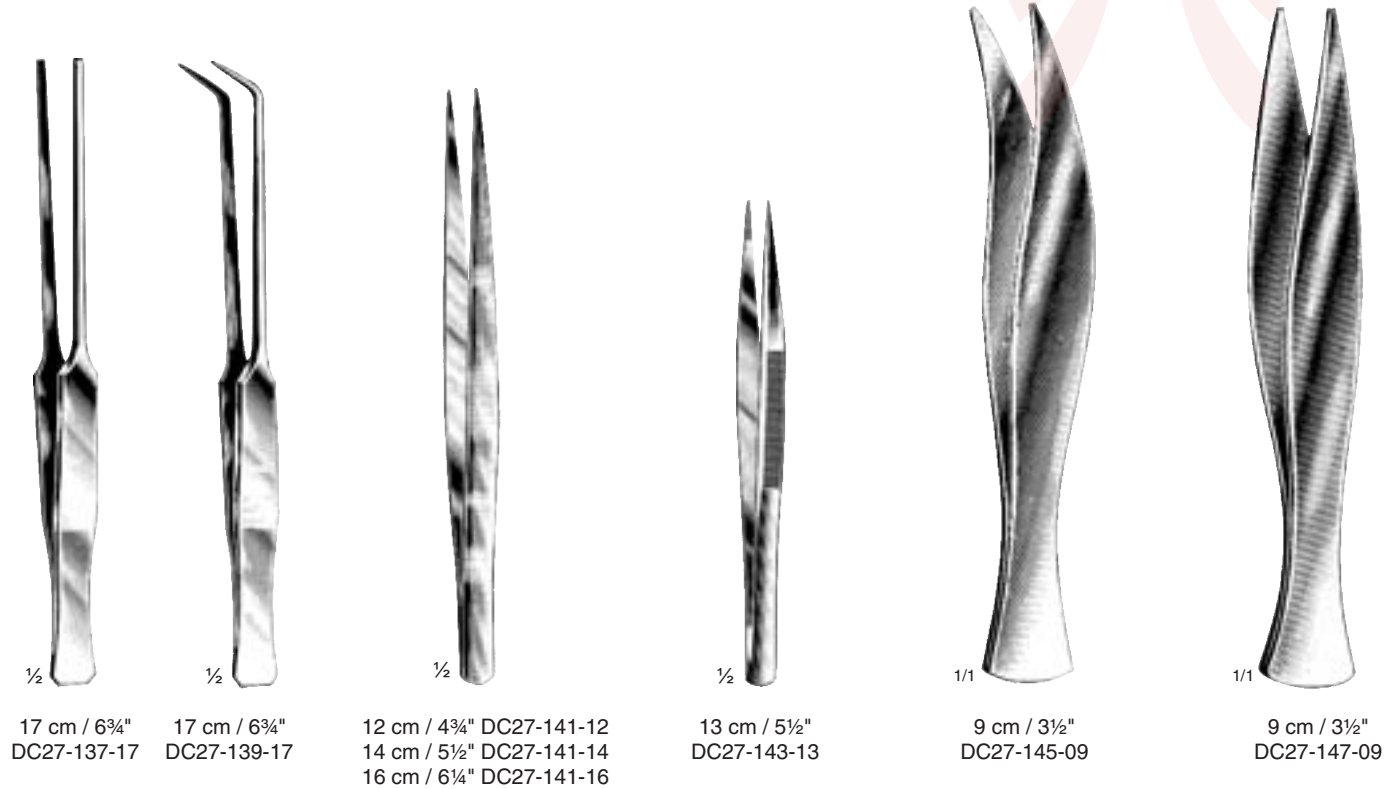
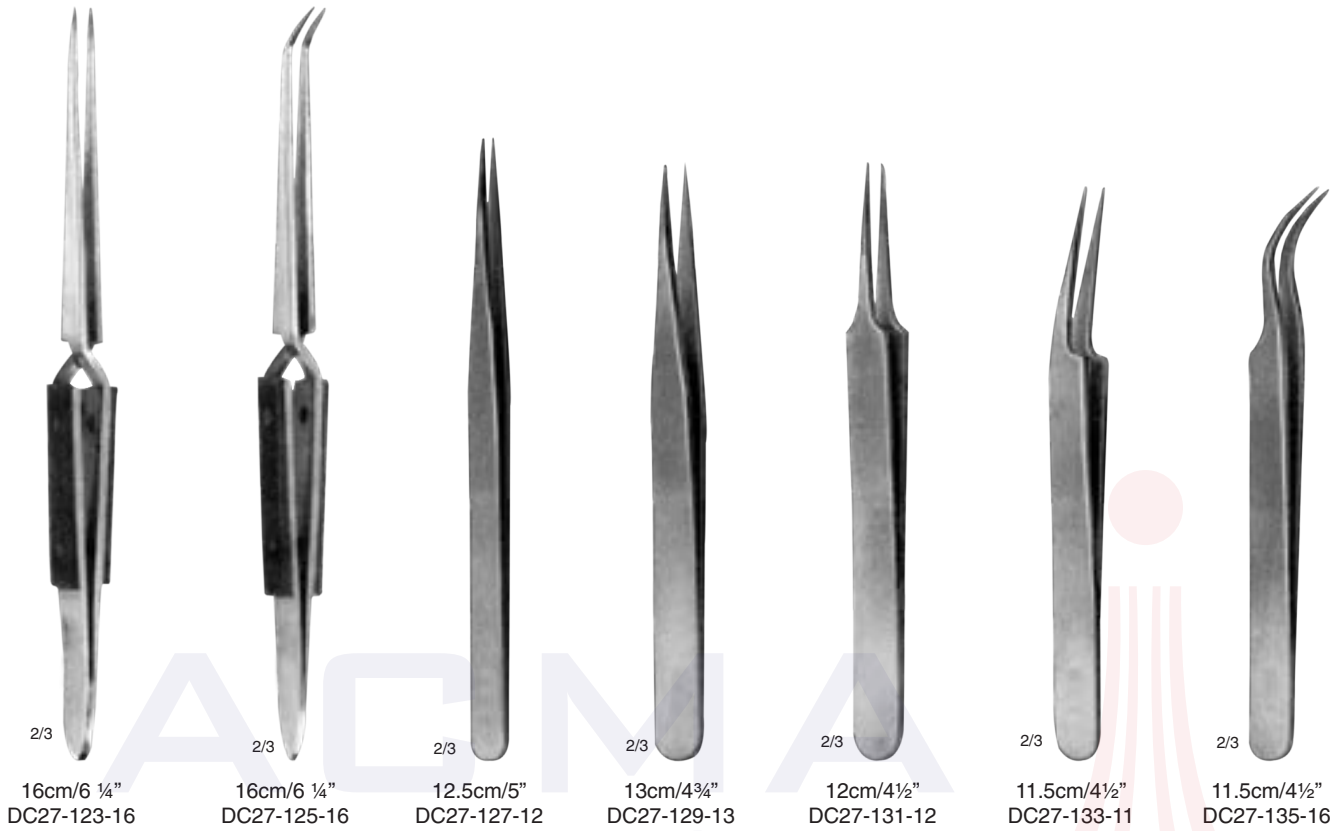

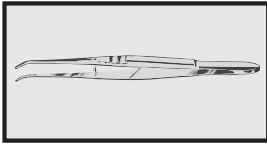

Forceps with Tungsten Carbide Inserts



Adson

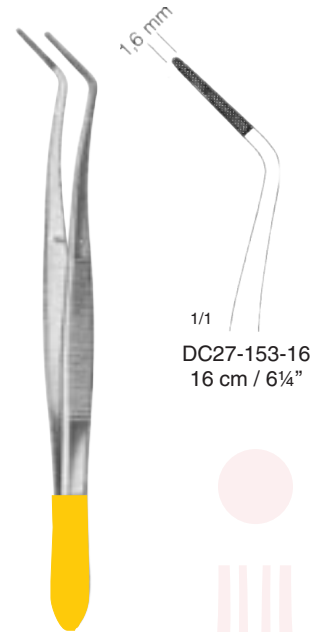
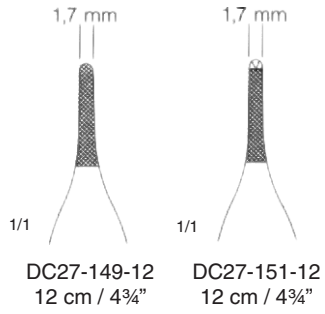

Meriam

1,6 mm
1/1
DC27-153-16
16 cm / 6¼"

ACMA
INTERNATIONAL



Standard

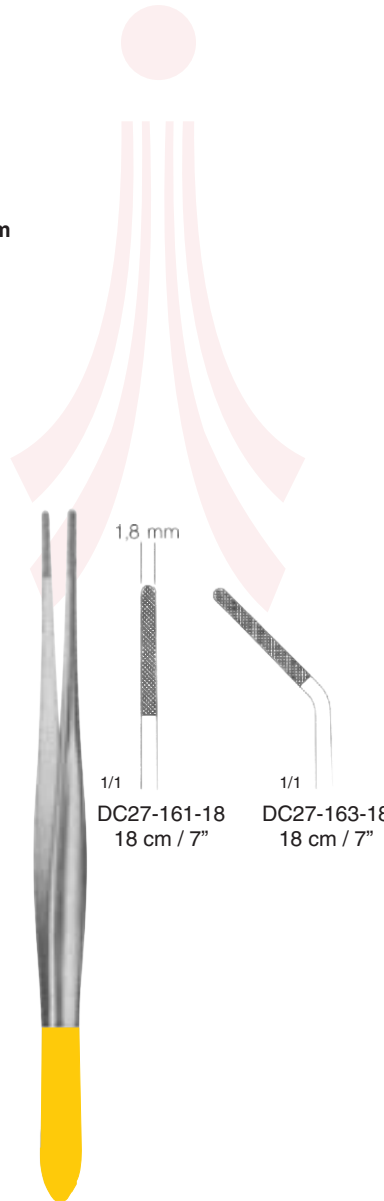
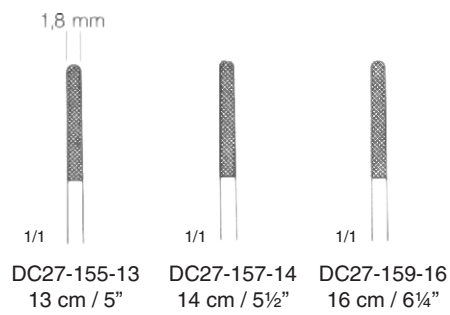

Cushing

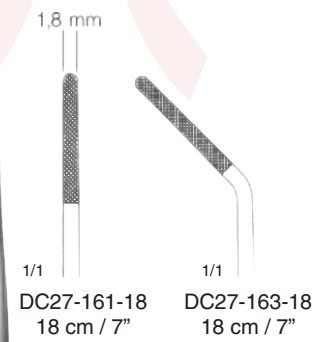

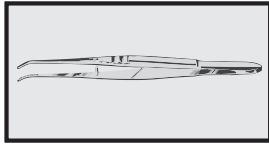

Forceps with Debakey tothing



DeBakey
DC27-165-16 = 16 cm/6 1/4"
DC27-165-20 = 20 cm/8"

DC27-167-16 = 16 cm/6 1/4"
DC27-167-20 = 20 cm/8"
DC27-167-24 = 24 cm/9 1/4"
DC27-167-30 = 30 cm/12"

DC27-169-16 = 16 cm/6 1/4"
DC27-169-20 = 20 cm/8"
DC27-169-24 = 24 cm/9 1/4"
DC27-169-30 = 30 cm/12"

De Bakey
DC27-171-16 = 16 cm/6 1/4"
DC27-171-20 = 20 cm/8"
DC27-171-24 = 24 cm/9 1/4"
DC27-171-30 = 30 cm/12"

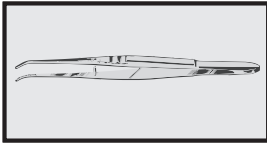

Cotton & Dressing Forceps



Periodontal pocket makers

15cm / 6"
DC27-173-30
(Crane-Kaplan)
Goldman-fox

15cm / 6"
DC27-175-30
(Crane-Kaplan)
Goldman-fox

16cm / 6½"
DC27-177-30
Fig-18L
Locking

15cm / 6"
DC27-179-30
Fig-1
Self Locking

15cm / 6"
DC27-181-30
Fig-2
Self Locking

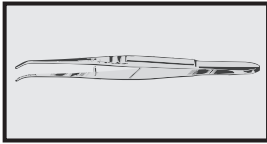

Splinter Forceps & Soldering Devices



14 cm/5 1/2"
DC27-193-30
self-retaining,
round ends



14 cm/5 1/2"
DC27-195-30
self retaining,
flat ends



	cm	inches	
DC27-197-30	12	4 3/4	DC27-199-12
DC27-197-14	14	5 1/2	DC27-199-14
DC27-197-16	16	6 1/4	DC27-199-16



13 cm/5 1/8"
DC27-201-13

ACMA INTERNATIONAL

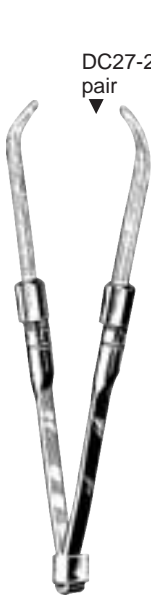

DC27-205-00
pair

13 cm/5 1/8"
DC27-203-13
DC27-205-00



16 cm/6 1/4"
DC27-207-19
DC27-209-00



DC27-213-00
pair

16 cm/6 1/4"
DC27-211-16
DC27-213-00



16 cm/6 1/4"
DC27-215-16 - DC27-221-02



DC27-215-16
Spare tips, in pairs



DC27-217-16

DC27-219-02 DC27-221-02

insulated handle